

SU(2) graph invariants, Regge actions and polytopes

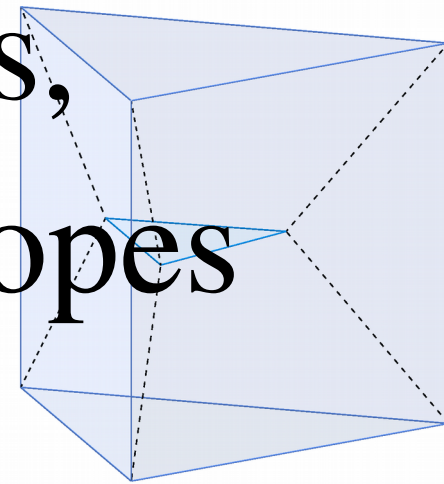

Pietro Dona'

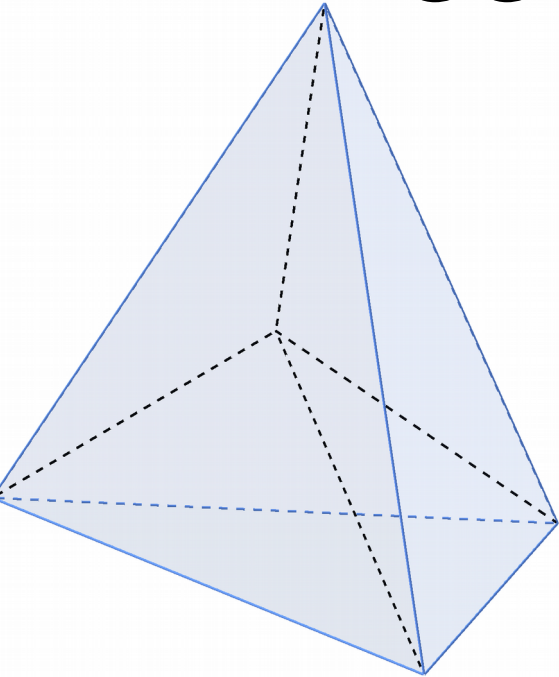
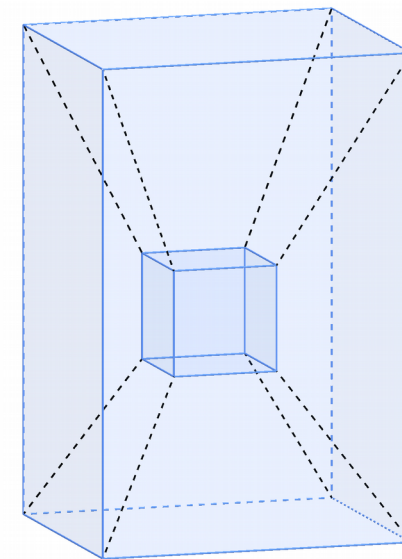

Based on [arXiv:1708.01727](https://arxiv.org/abs/1708.01727)

P.D. M. Fanizza, G. Sarno and S. Speziale

ILQG Seminar

10th October 2017



PennState
Eberly College
of Science



PennState

Eberly College of Science

Pietro Dona'



Simone Speziale*

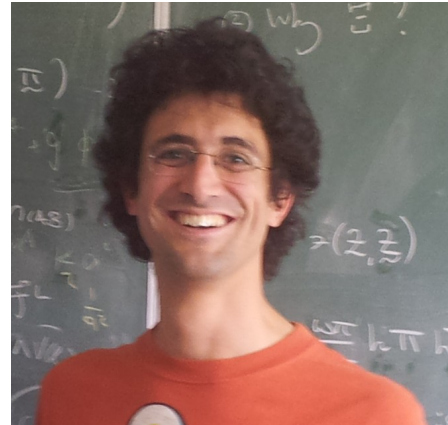

Giorgio Sarno and Marco Fanizza

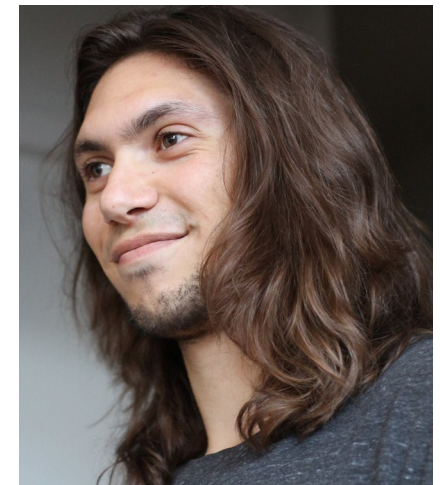

SCUOLA
NORMALE
SUPERIORE

Motivations

SU(2) invariants are commonly used in a variety of physical problems: quantum optics, nuclear physics or **quantum gravity**.

3D quantum gravity for large spins
and euclidean tetrahedron
[Ponzano, Regge - 1968]

$$\left\{ \begin{array}{ccc} j_1 & j_2 & j_3 \\ j_4 & j_5 & j_6 \end{array} \right\} \approx \frac{1}{\sqrt{12\pi V}} \cos \left(\sum_i \left(j_i + \frac{1}{2} \right) \theta_i + \frac{\pi}{4} \right)$$

Many generalizations: {9j} symbol [Haggard and Littlejohn - 2010], {6j} for non-compact groups SU(1,1) [Davids - 2000], quantum group SU_q(2) [Taylor and Woodward - 2006]

Motivated by the efforts of the LQG community to find dynamical transition amplitudes in the spin foam formalism the asymptotic of invariants associated with the graph of a 4-simplex has been studied.

SU(2) vertex amplitude [Barrett, Fairbairn and Hellmann - 2010]

SO(4) vertex amplitude [Barrett, Dowdall, Fairbairn, Gomes and Hellmann - 2009]

EPRL vertex amplitude [Barrett, Dowdall, Fairbairn, Hellmann and Pereira - 2010]

Time-like boundary [Kaminski, Kisielowski and Sahlmann - 2017]

Quantum group SL_q(2,C) [Haggard, Han, Kaminski and Riello - 2016]

The generalization of the Regge action to the 4D Lorentzian geometry is the major achievement of the EPRL model.



Motivations

SU(2) invariants are commonly used in a variety of physical problems: quantum optics, nuclear physics or **quantum gravity**.

3D quantum gravity for large spins
and euclidean tetrahedron
[Ponzano, Regge - 1968]

$$\left\{ \begin{array}{ccc} j_1 & j_2 & j_3 \\ j_4 & j_5 & j_6 \end{array} \right\} \approx \frac{1}{\sqrt{12\pi V}} \cos \left(\sum_i \left(j_i + \frac{1}{2} \right) \theta_i + \frac{\pi}{4} \right)$$

Many generalizations: {9j} symbol [Haggard and Littlejohn - 2010], {6j} for non-compact groups SU(1,1) [Davids - 2000], quantum group SU_q(2) [Taylor and Woodward - 2006]

Motivated by the efforts of the LQG community to find dynamical transition amplitudes in the spin foam formalism the asymptotic of invariants associated with the graph of a 4-simplex has been studied.

SU(2) vertex amplitude [Barrett, Fairbairn and Hellmann - 2010]

SO(4) vertex amplitude [Barrett, Dowdall, Fairbairn, Gomes and Hellmann - 2009]

EPRL vertex amplitude [Barrett, Dowdall, Fairbairn, Hellmann and Pereira - 2010]

Time-like boundary [Kaminski, Kisielowski and Sahlmann - 2017]

Quantum group SL_q(2,C) [Haggard, Han, Kaminski and Riello - 2016]

Simpler analysis but same saddle point geometry of the Lorentzian models.

Optimal playground to start doing numerics.

Outline

Overview of the SU(2) amplitude asymptotic

with less math but more geometry

clear interpretation in terms of shape matching constraint

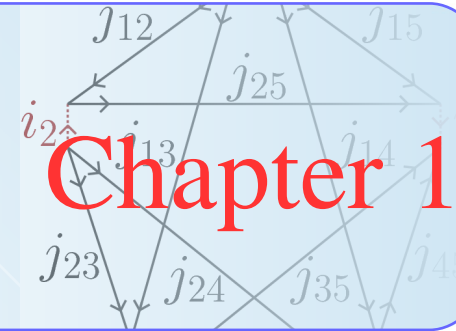

Numerical results

challenges and applications

first numerical confirmation of the formula

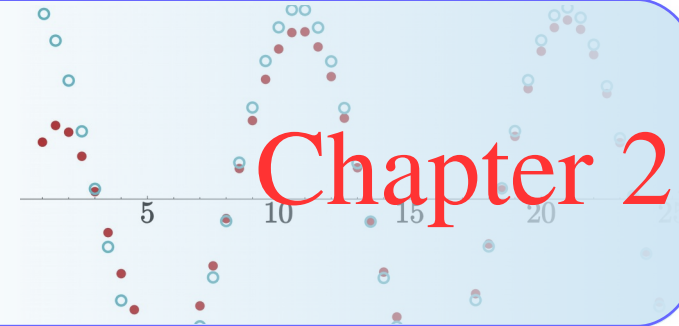

Extension to arbitrary valence

dynamics to arbitrary spin networks

what is the semi-classical limit in this case?

areas are not enough to characterize polytopes (4C-10)

not all the volume simplicity constraints are imposed [Belov - 2017]

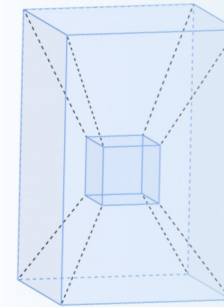

Definition of the amplitude

The amplitude is a linear combination of $\{15j\}$ symbols with coefficients constructed from coherent states of the intertwiner space.

$$A_v(j_{ab}, \vec{n}_{ab}) = \sum_{\{i_a\}} \prod_a d_{i_a} \text{Diagram}$$

Definition of the amplitude

What are the **variables**?

- 10 spins j_{ab} with $a < b$
 $a, b = 1, \dots, 5$
- 20 unitary vectors \vec{n}_{ab}

geometrical data of 5 tetrahedra*!

j_{ab} area of the face “shared” between tet a and b

\vec{n}_{ab} normal to the face b of the tet a

Quantum tetrahedron

- Livine-Speziale **coherent states**

$$||\{j_{ab}, \vec{n}_{ab}\}\rangle := \int dg \bigotimes_{(ab)} g \triangleright |j_{ab}, \vec{n}_{ab}\rangle$$

[Livine and Speziale – 2007]

[Bianchi, D., Speziale – 2011]

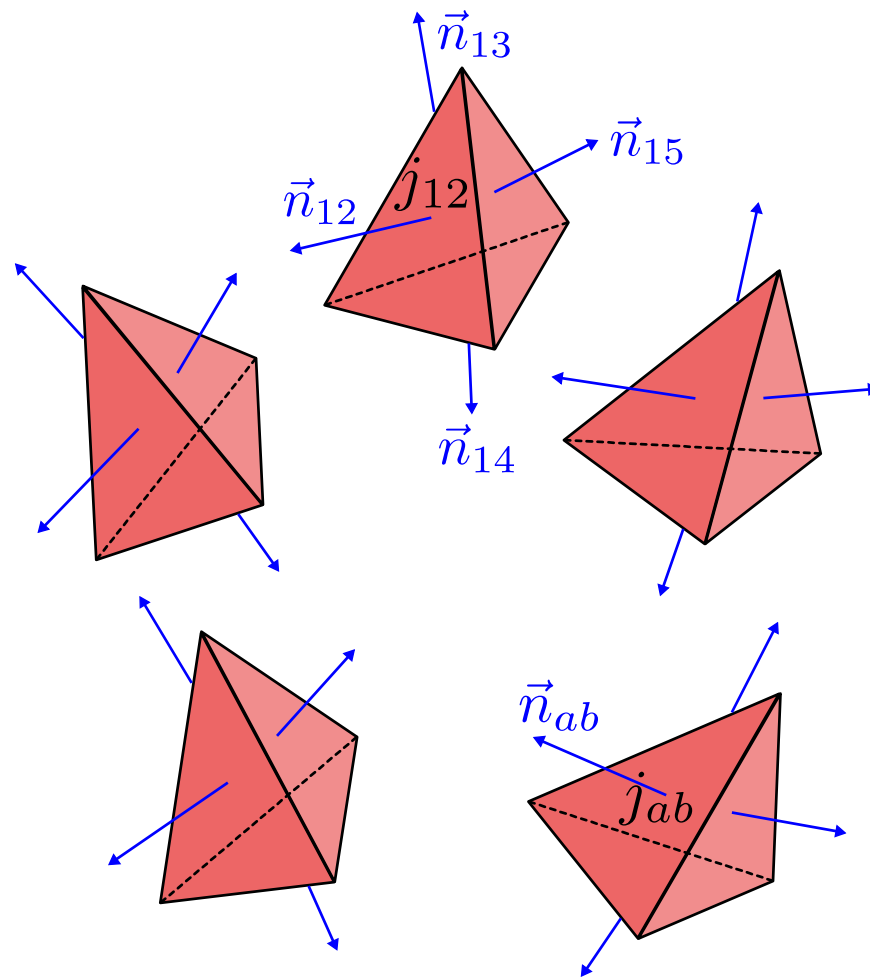

$$\langle \{j_{ab}\}, i || \{j_{ab}, \vec{n}_{ab}\} \rangle =$$

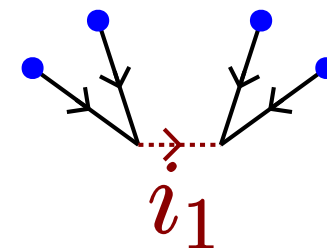

* if closure constraint is satisfied.

Definition of the amplitude

What are the **variables**? geometrical data of 5 tetrahedra!

10 spins j_{ab} (areas) and 20 unitary vectors \vec{n}_{ab}

(5 x 4 normals to the faces)

Quantum tetrahedron

(LS coherent state)

$$\langle \{j_{ab}\}, i \mid \{j_{ab}, \vec{n}_{ab}\} \rangle$$

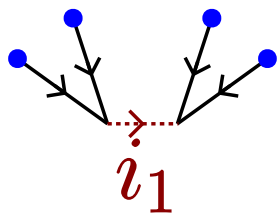

$$A_v(j_{ab}, \vec{n}_{ab}) =$$

$$\sum_{\{i_a\}} \prod_a d_{i_a}$$

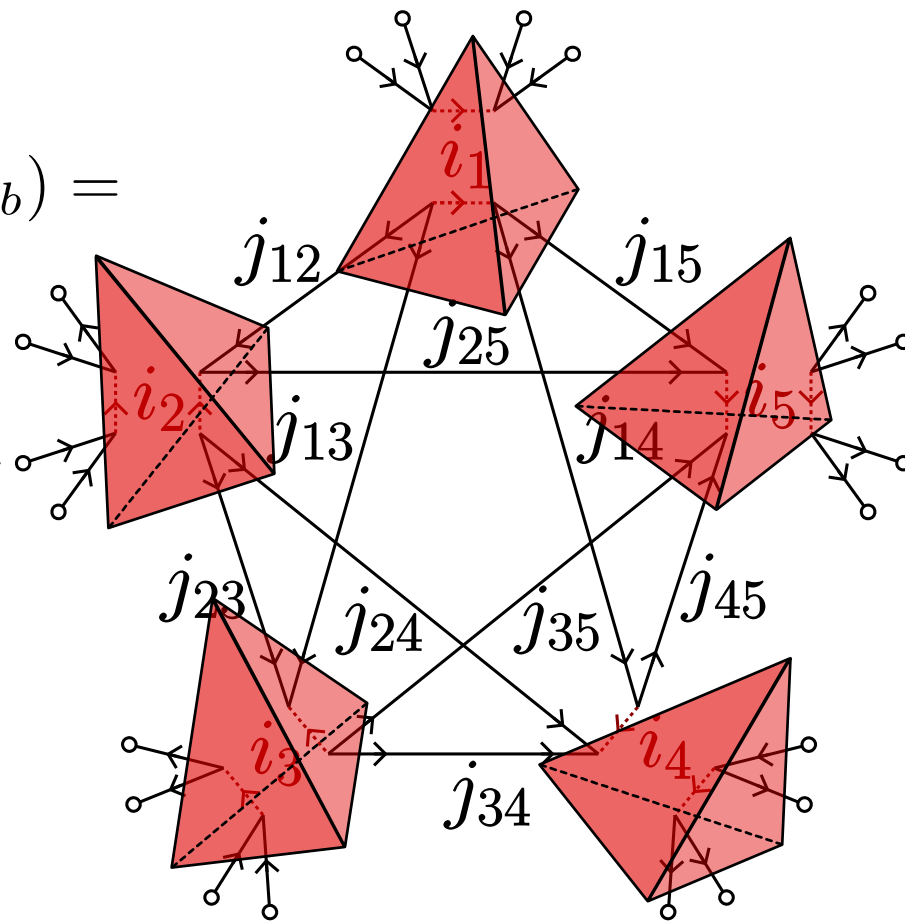

Definition of the amplitude

What are the **variables**? geometrical data of 5 tetrahedra!

10 spins j_{ab} (areas) and 20 unitary vectors \vec{n}_{ab}

(5 x 4 normals to the faces)

Quantum tetrahedron

(LS coherent state)

$$\langle \{j_{ab}\}, i \mid \{j_{ab}, \vec{n}_{ab}\} \rangle$$

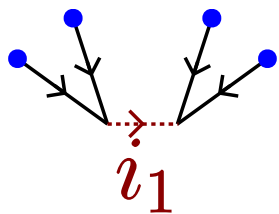

$$A_v(j_{ab}, \vec{n}_{ab}) =$$

$$\sum_{\{i_a\}} \prod_a d_{i_a}$$

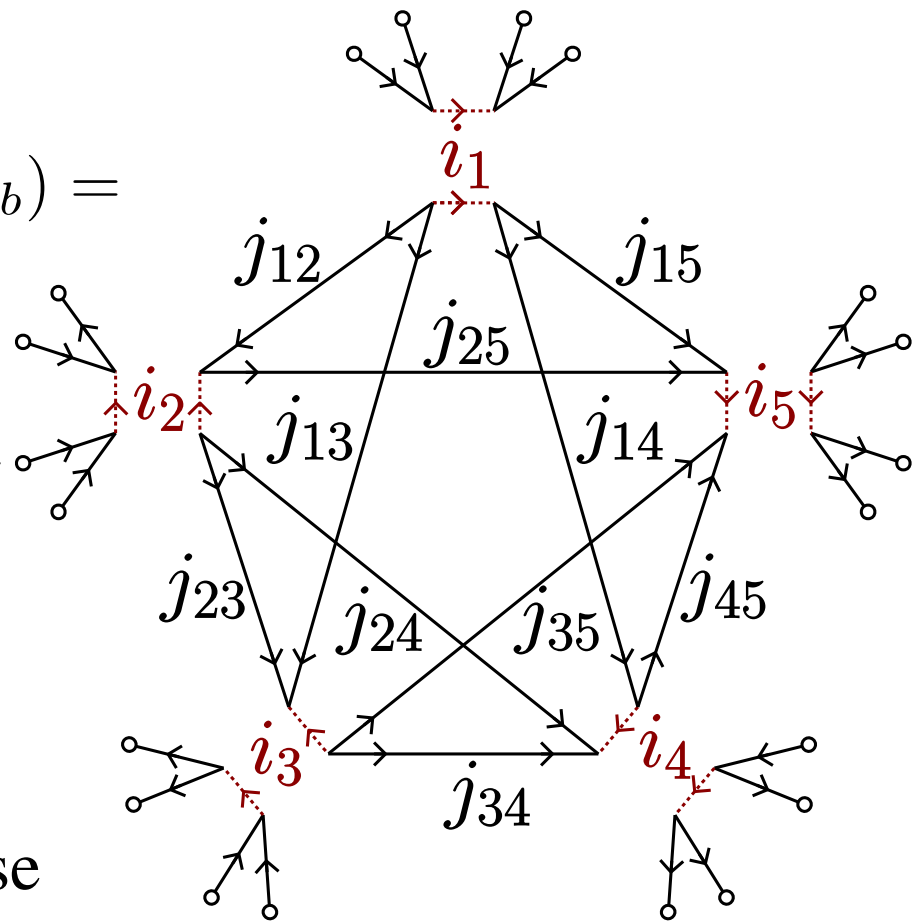

For our purpose is more convenient to use an integral form

$$A_v(j_{ab}, \vec{n}_{ab}) = \int \prod_a dg_a \prod_{(ab)} \left\langle \frac{1}{2}, -\vec{n}_{ab} \mid g_a^{-1} g_b \mid \frac{1}{2}, \vec{n}_{ba} \right\rangle^{2j_{ab}}$$

The saddle point approximation

Asymptotic behavior $j_{ab} \rightarrow \lambda j_{ab}$! By **saddle point** approximation.

$$S(g_a; j_{ab}, \vec{n}_{ab}) = \sum_{1 \leq a < b \leq 5} 2j_{ab} \log \langle -\vec{n}_{ab} | g_a^\dagger g_b | \vec{n}_{ba} \rangle$$

Critical Points (CP) equations:

[Barrett, Fairbairn and Hellmann - 2010]

$$R_b \vec{n}_{ba} = -R_a \vec{n}_{ab}$$

$$\sum_{b \neq a} j_{ab} \vec{n}_{ab} = 0 \quad \forall a.$$

- the first equation comes from extremizing $\text{Re}[S]$
- the second equation comes from requiring stationary phase
- R_a is the $\text{SU}(2)$ matrix g_a in the adjoint representation

The saddle point approximation

Asymptotic behavior $j_{ab} \rightarrow \lambda j_{ab}$! By **saddle point** approximation.

Critical points (CP) equations: $R_b \vec{n}_{ba} = -R_a \vec{n}_{ab} \quad \sum_{b \neq a} j_{ab} \vec{n}_{ab} = 0 \quad \forall a.$

Is there a convenient gauge? Introducing the *Twisted spike* $\vec{n}_{ba} = -\vec{n}_{ab}$

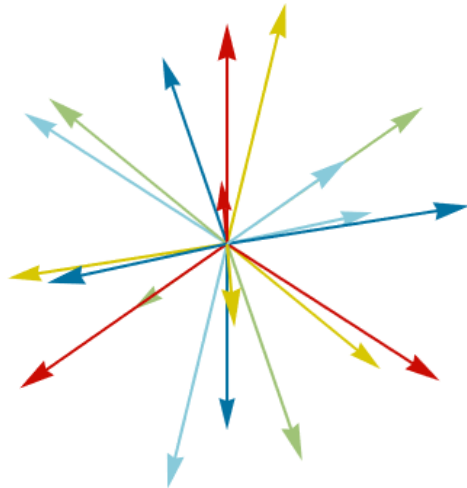

the normals of the boundary tetrahedra

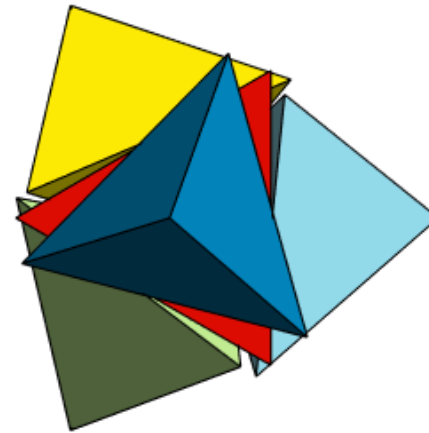

A 3D picture of an Euclidean 4Simplex

If the five tetrahedra are the boundary of an Euclidean 4Simplex the twist angle coincide with the 4D dihedral angle*. Ask if interested/look at the end.

* analogy with how is encoded extrinsic curvature in Twisted Geometries.

The saddle point approximation

Asymptotic behavior $j_{ab} \rightarrow \lambda j_{ab}$! By **saddle point** approximation.

Critical points (CP) equations: $R_b \vec{n}_{ba} = -R_a \vec{n}_{ab} \quad \sum_{b \neq a} j_{ab} \vec{n}_{ab} = 0 \quad \forall a.$

Is there a convenient gauge? Introducing the *Twisted spike* $\vec{n}_{ba} = -\vec{n}_{ab}$

If this gauge does not exist there are **no solutions** of the CP equations

The saddle point approximation

Asymptotic behavior $j_{ab} \rightarrow \lambda j_{ab}$! By **saddle point** approximation.

Critical points (CP) equations: $R_b \vec{n}_{ba} = -R_a \vec{n}_{ab} \quad \sum_{b \neq a} j_{ab} \vec{n}_{ab} = 0 \quad \forall a.$

Is there a convenient gauge? Introducing the *Twisted spike* $\vec{n}_{ba} = -\vec{n}_{ab}$

If this gauge does not exist there are **no solutions** of the CP equations

One immediate solution

$$R_a = \mathbb{1}$$

Vector Geometry

a characterization of the vector geometries space is easy in this gauge. Ask if interested/look at the end

The saddle point approximation

Asymptotic behavior $j_{ab} \rightarrow \lambda j_{ab}$! By **saddle point** approximation.

Critical points (CP) equations: $R_b \vec{n}_{ba} = -R_a \vec{n}_{ab} \quad \sum_{b \neq a} j_{ab} \vec{n}_{ab} = 0 \quad \forall a.$

Is there a convenient gauge? Introducing the *Twisted spike* $\vec{n}_{ba} = -\vec{n}_{ab}$

If this gauge does not exist there are **no solutions** of the CP equations

One immediate solution

$$R_a = \mathbb{1}$$

Vector Geometry

a characterization of the vector geometries space is easy in this gauge. Ask if interested/look at the end

Non trivial solutions

$$\begin{aligned} R_1 &= \mathbb{1} \\ R_b &= e^{i2\theta_{1b} \vec{n}_{b1} \cdot \vec{J}} \end{aligned}$$

Regge Geometry

$$\cos \theta_{ab} = \cos \theta_{ab}^{(c)}(\varphi) = \frac{\cos \varphi_{ab}^{(c)} + \cos \varphi_{ac}^{(b)} \cos \varphi_{bc}^{(a)}}{\sin \varphi_{ac}^{(b)} \sin \varphi_{bc}^{(a)}}$$

$$\cos \varphi_{bc}^{(a)} := \vec{n}_{ab} \cdot \vec{n}_{ac}$$

edge independence = angle matching = shape matching

[Dittrich and Speziale - 2008]

Asymptotic formula

$$j_{ab} \rightarrow \lambda j_{ab}$$

dofs	Geometry type	Saddle points	Behavior
20	twisted	0	Exponentially decreasing

Asymptotic formula

$$j_{ab} \rightarrow \lambda j_{ab}$$

dofs	Geometry type	Saddle points	Behavior
20	twisted	0	Exponentially decreasing
15	vector (<i>anti-parallel</i>)	1	Power law decreasing without oscillations

$$A_v(j_{ab}, \vec{n}_{ab}) = \left(\frac{2\pi}{\lambda}\right)^6 \frac{2^4}{(4\pi)^8} \frac{1}{\sqrt{\det -H^{(0)}}} + O(\lambda^{-7}).$$

Asymptotic formula

$$j_{ab} \rightarrow \lambda j_{ab}$$

dofs	Geometry type	Saddle points	Behavior
20	twisted	0	Exponentially decreasing
15	vector (<i>anti-parallel</i>)	1	Power law decreasing without oscillations
10	Regge (<i>shape-matching</i>)	2	Power law decreasing Regge oscillations

$$S_R := \sum_{(ab)} j_{ab} \theta_{ab}(\varphi)$$

$$A_v(j_{ab}, \vec{n}_{ab}) = \left(\frac{2\pi}{\lambda}\right)^6 \frac{2^4}{(4\pi)^8} \frac{e^{i\lambda S_R}}{\sqrt{|\det -H^{(0)}|}} \cos\left(\lambda S_R - \frac{1}{2} \arg \det -H^{(0)}\right) + O(-7)$$

Numerical results

Two available paths:

Numerical integration,
MonteCarlo techniques

- Oscillatory integrals requires adaptive methods with **slow convergence**
- Warm-up **exercise** for Lorentzian EPRL

Explicit summation of
the $\{15j\}$ symbols

- **Efficient** way to compute invariants is a problem solved by mathematicians [Johansson and Forssen - 2016]
- Strategy: **consider reducible $\{15j\}$**

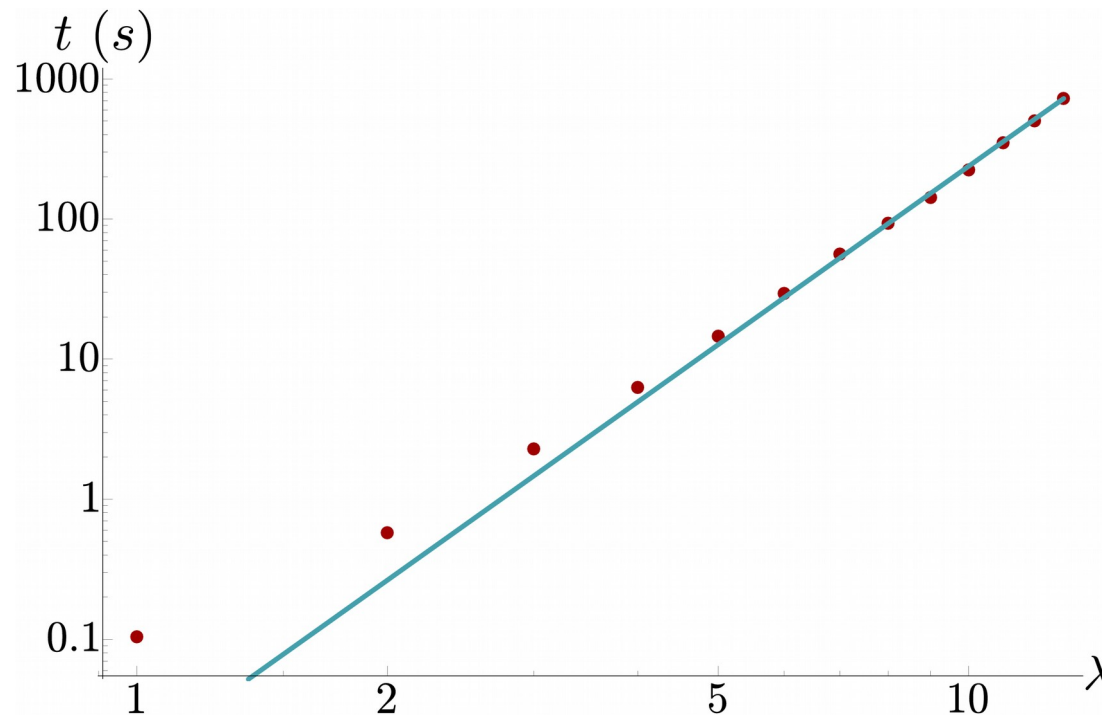

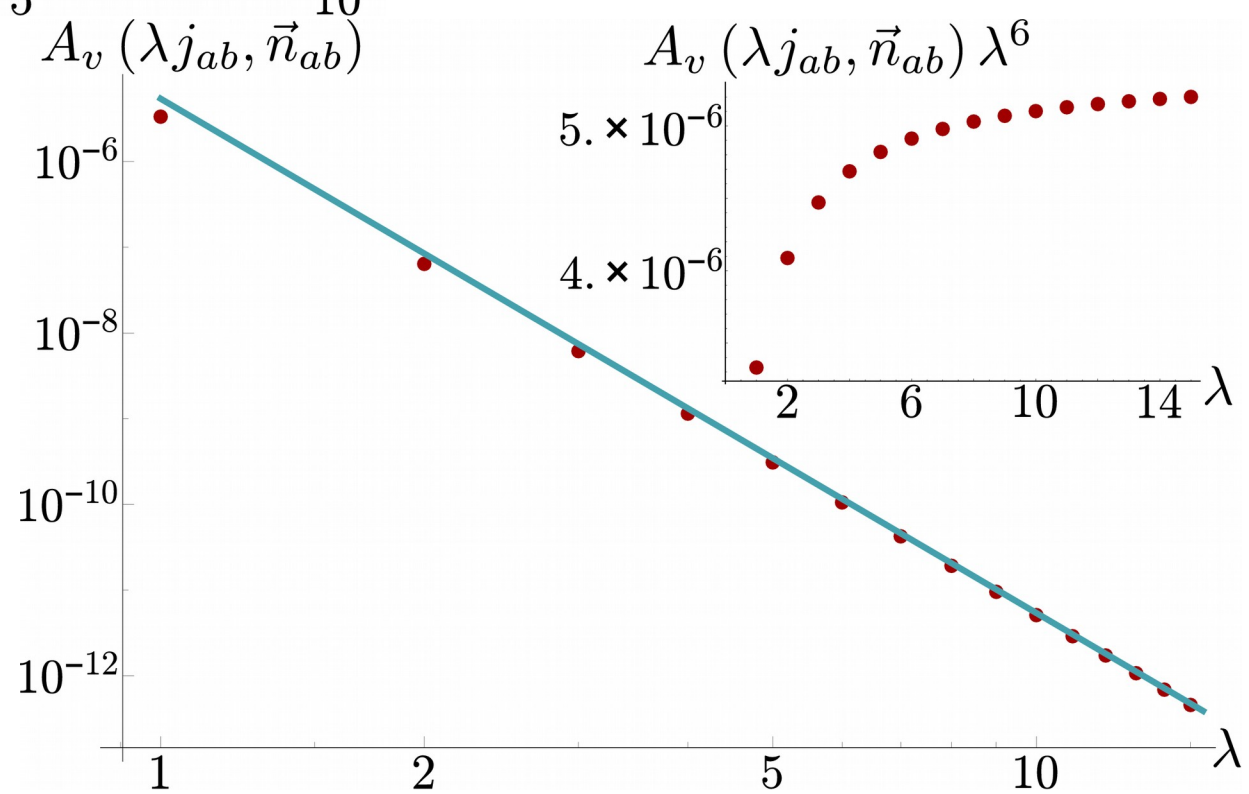
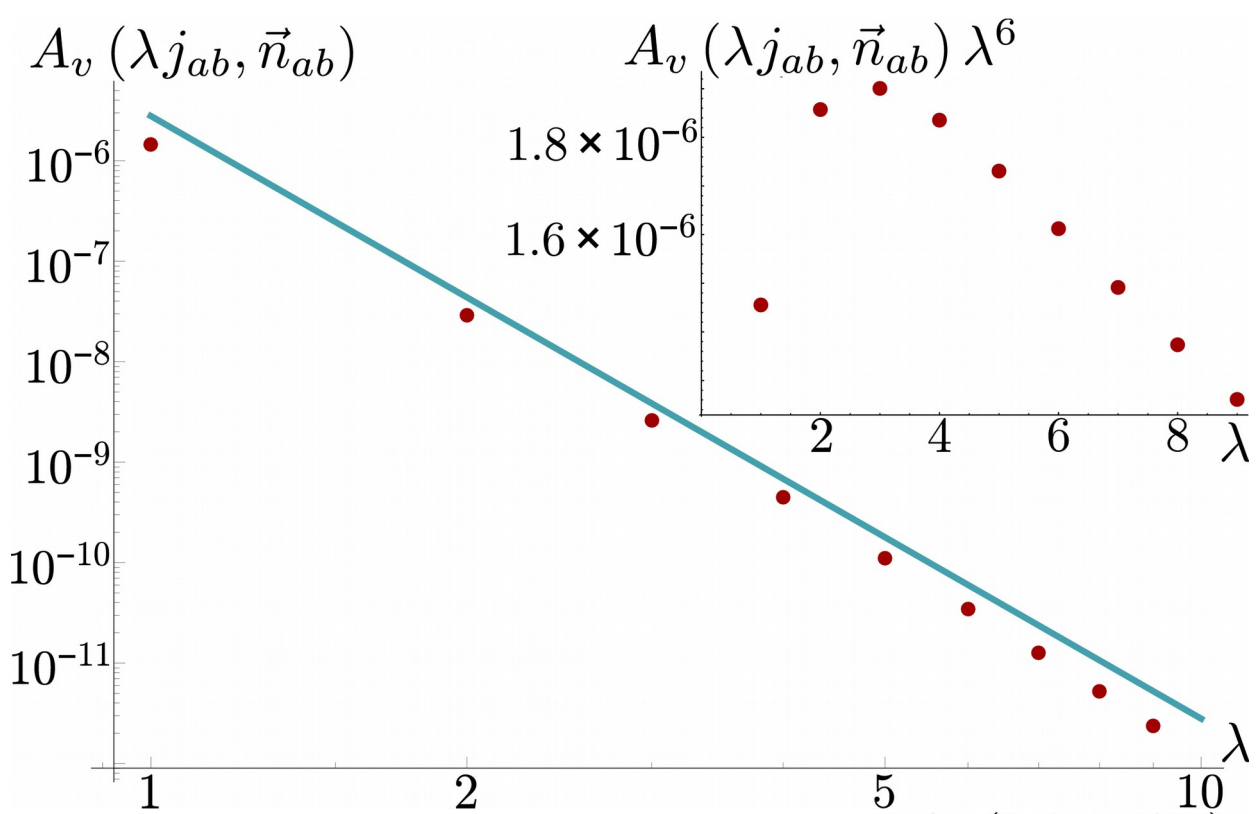

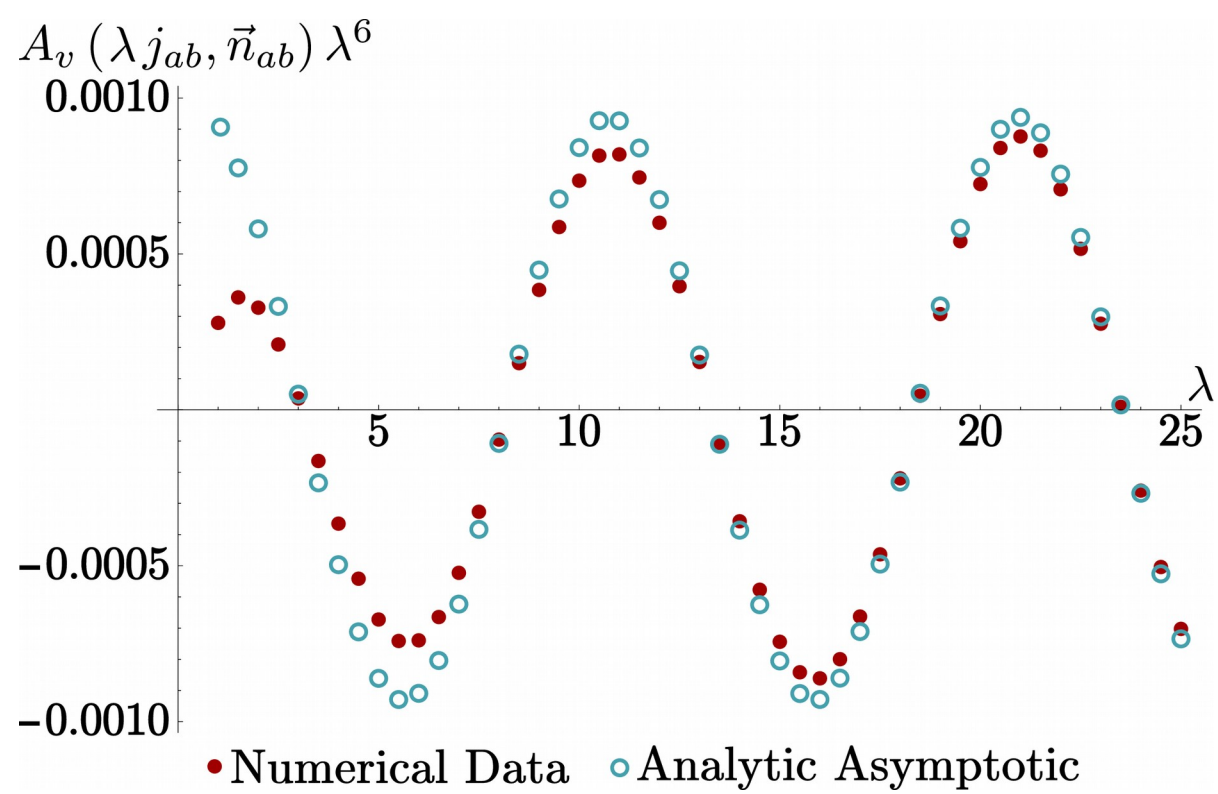

Equilateral 4-Simplex

Semi-classical region for relatively small spins

Isosceles 4-Simplex

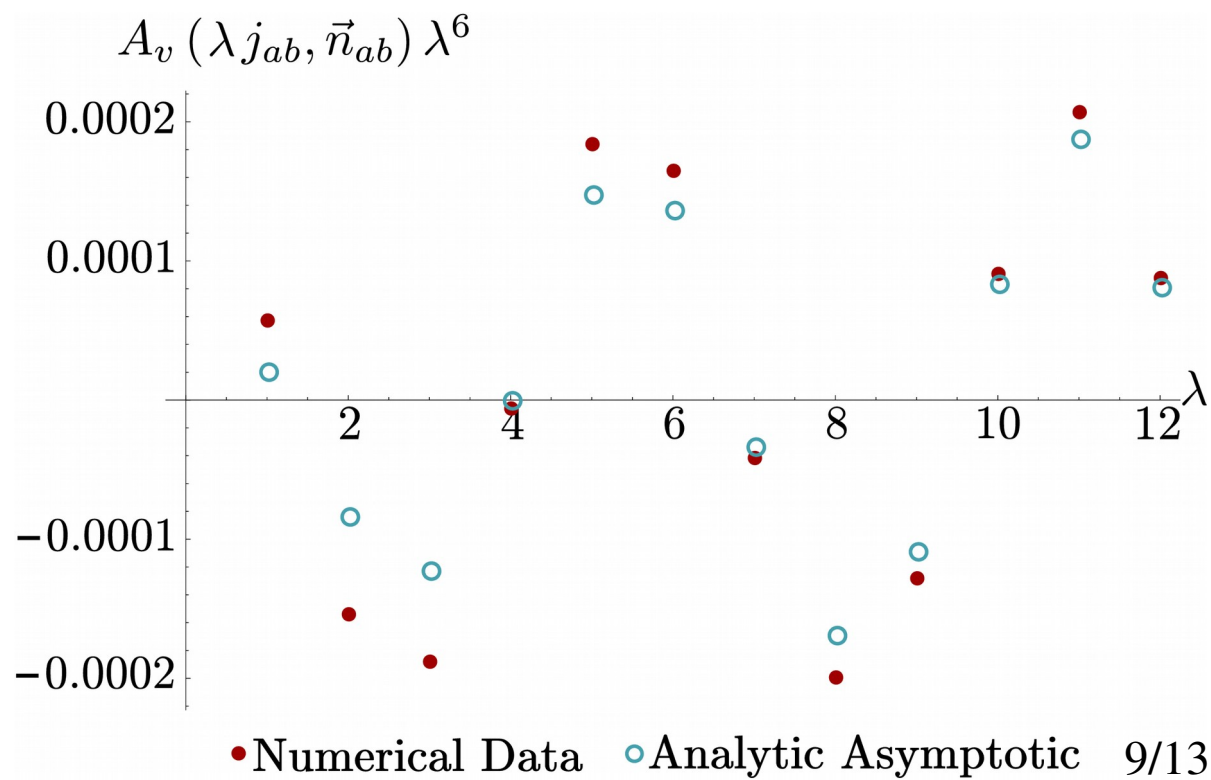

Next to leading order

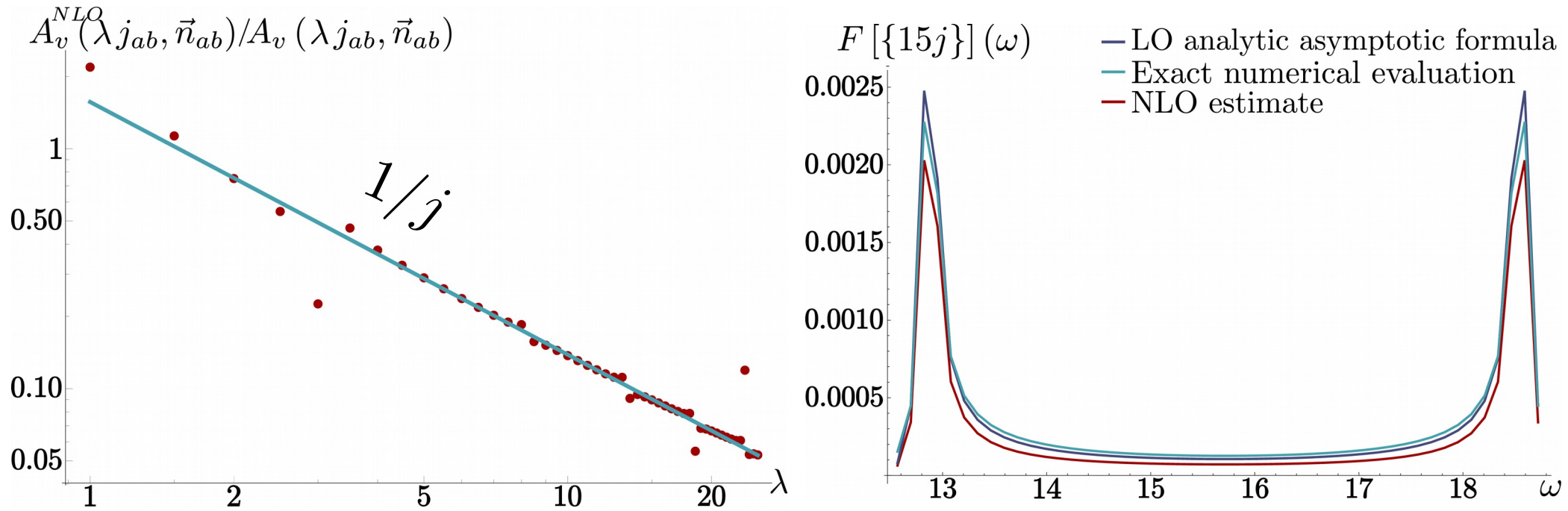

Expected by the saddle point approximation

Unknown **amplitude and phase** make it difficult – different kind of analysis

Correction to semi-classical regime are numerically accessible

Careful interpretation – NO higher curvature terms

Higher valence and polytopes

The action is “**local**”, leads to the same critical points equations.

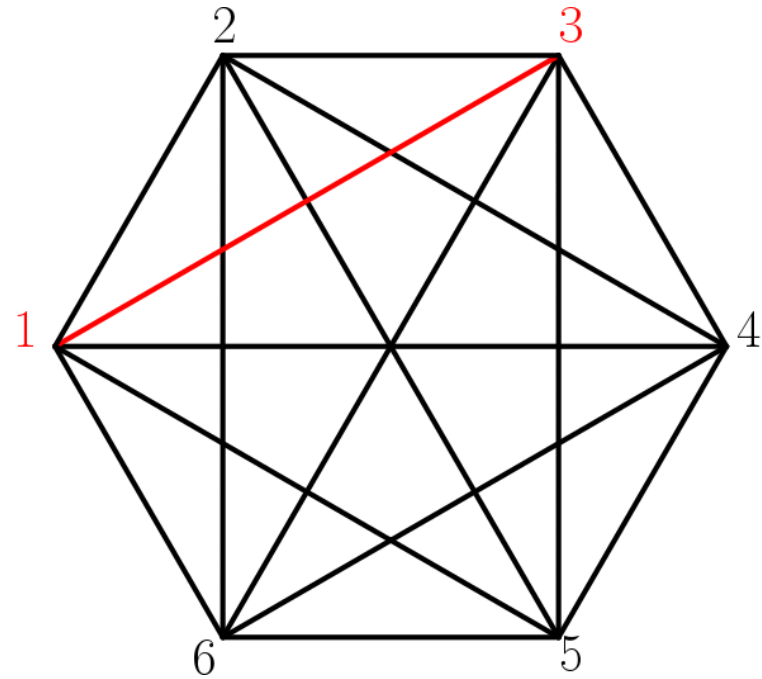
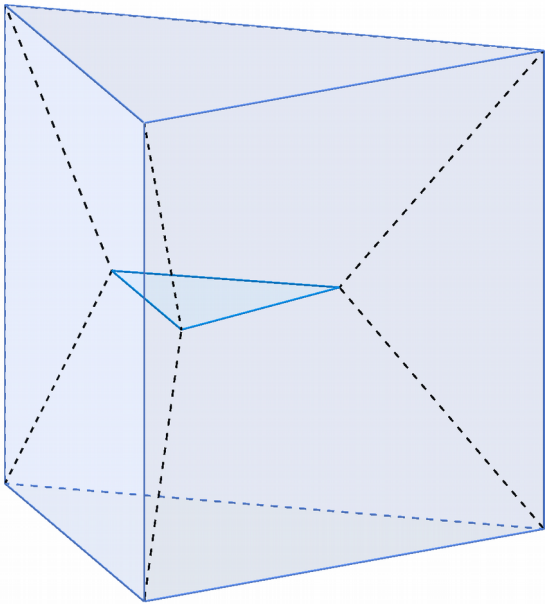

$$A_v(j_{ab}, \vec{n}_{ab}) = \int \prod_a dg_a \prod_{(ab)} \left\langle \frac{1}{2}, -\vec{n}_{ab} \left| g_a^{-1} g_b \right| \frac{1}{2}, \vec{n}_{ba} \right\rangle^{2j_{ab}}$$

The main difference is in the treatment of nodes not first-neighbours, but our procedure, which does not rely on Bivector reconstruction theorem, extends naturally.

Higher valence and polytopes

The action is “**local**”, leads to the same critical points equations.

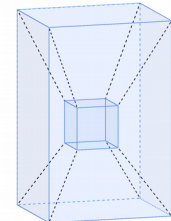
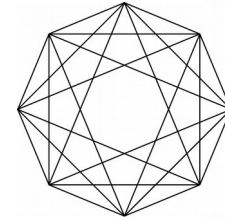
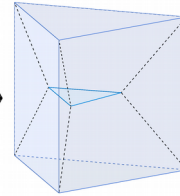
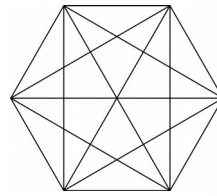

Dofs	Geometry type	Saddle points	Behavior
5L-6N	twisted	0	Exponentially decreasing
3L-3N	vector (<i>anti-parallel</i>)	1	Power law decreasing without oscillations

Higher valence and polytopes

The action is “**local**”, leads to the same critical points equations.

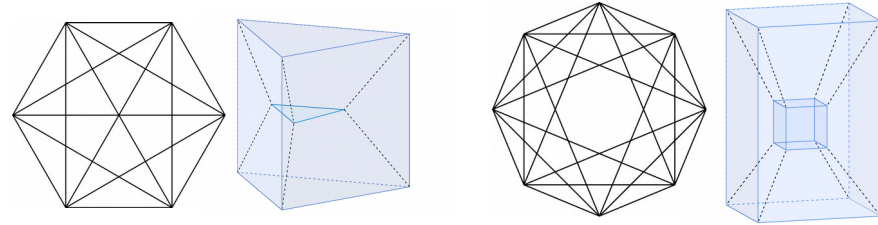

Dofs	Geometry type	Saddle points	Behavior
5L-6N	twisted	0	Exponentially decreasing
3L-3N	vector (<i>anti-parallel</i>)	1	Power law decreasing without oscillations

Looking for a second equation: (same conditions before)

$$\cos \theta_{ab} = \cos \theta_{ab}^{(c)}(\varphi) = \frac{\cos \varphi_{ab}^{(c)} + \cos \varphi_{ac}^{(b)} \cos \varphi_{bc}^{(a)}}{\sin \varphi_{ac}^{(b)} \sin \varphi_{bc}^{(a)}}$$

edge independence is equivalent to **angle matching** but not shape matching!

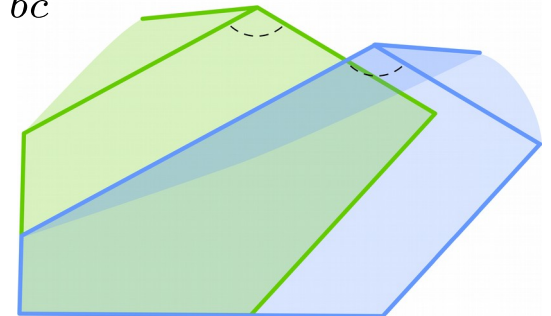

Higher valence and polytopes

The action is “**local**”, leads to the same critical points equations.

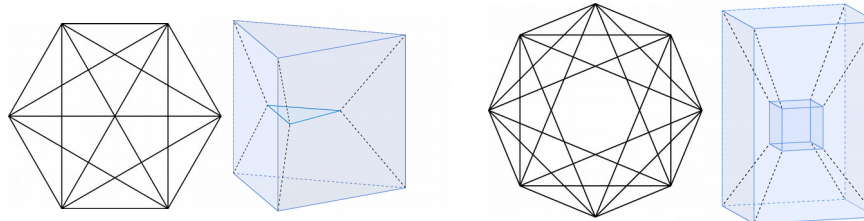

Dofs	Geometry type	Saddle points	Behavior
5L-6N	twisted	0	Exponentially decreasing
3L-3N	vector (<i>anti-parallel</i>)	1	Power law decreasing without oscillations
	Conformal twisted (<i>angle-matching</i>)	2	Power law decreasing generalized Regge oscillations

$$S_{\Gamma}[j_{ab}, \varphi_{bc}^{(a)}, \lambda_{a,b}, \mu_{ab,cd}] = \sum j_{ab} \theta_{ab}(\varphi) + \sum \lambda_{a,b} C_{a,b}(j, \varphi) + \sum \mu_{ab,cd} C_{ab,cd}(\varphi)$$

uniquely defined

closure

angle matching

Easy to glue!

Not enough constraints to write lengths in terms of Areas and Angles

Does it have a well-defined continuum limit?

Higher valence and polytopes

The action is “**local**”, leads to the same critical points equations.

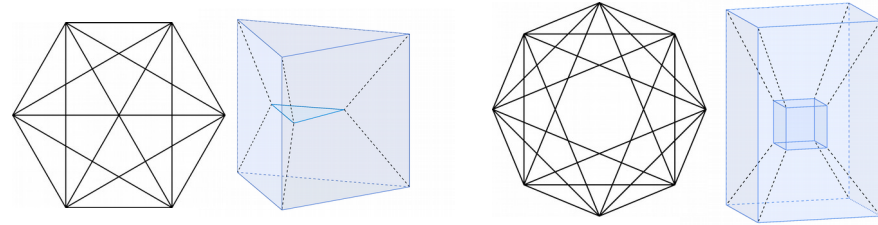

Dofs	Geometry type	Saddle points	Behavior
5L-6N	twisted	0	Exponentially decreasing
3L-3N	vector (<i>anti-parallel</i>)	1	Power law decreasing without oscillations
	Conformal twisted (<i>angle-matching</i>)	2	Power law decreasing generalized Regge oscillations
2L-2N	Regge (<i>shape-matching</i>)	2	Power law decreasing generalized Regge oscillations

We can restrict to full shape matched subspace. In general not flatly embeddable. Curved bulk is allowed. Classical limit to be studied.

Higher valence and polytopes

The action is “**local**”, leads to the same critical points equations.

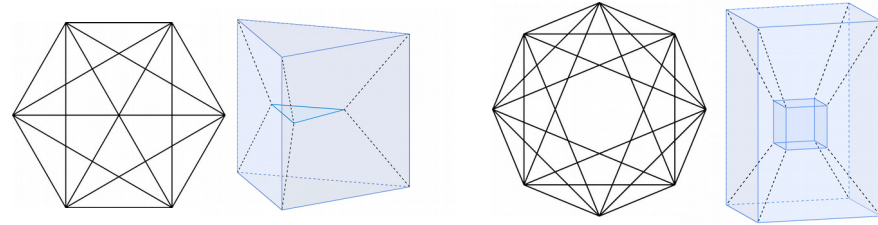

Dofs	Geometry type	Saddle points	Behavior
5L-6N	twisted	0	Exponentially decreasing
3L-3N	vector <i>(anti-parallel)</i>	1	Power law decreasing without oscillations
	Conformal twisted <i>(angle-matching)</i>	2	Power law decreasing generalized Regge oscillations
2L-2N	Regge <i>(shape-matching)</i>	2	Power law decreasing generalized Regge oscillations
4N-10	polytope <i>(flat embedding)</i>	2	Power law decreasing Regge oscillations

*We have a
criterion*

Conclusion and Outlook

Numerical results

High accuracy already at low spins, and insights on higher order corrections

Gathered expertise to attack the EPRL problem

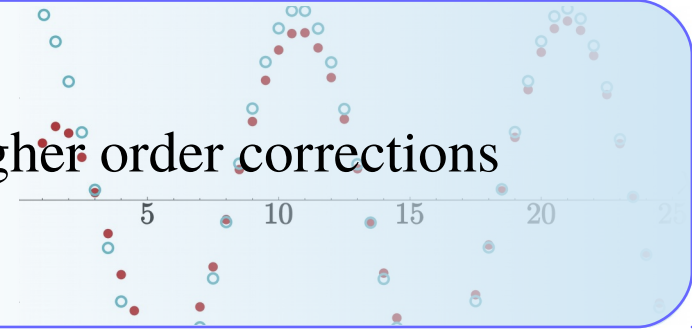

Extension to arbitrary valence

The analytic results of the asymptotic analysis extend to more general graphs

Two distinct saddle points appears for angle matched configurations

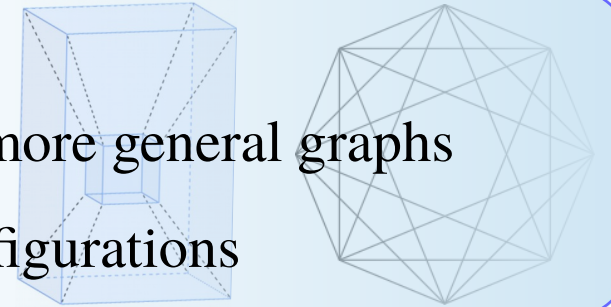

Extensions to EPRL model (work in progress)

Our results apply to $SU(2)$ graph invariants and BF theory but they are relevant also for constrained BF models

Generalized vertices (KKL) and extended 4D triangulations

Computation of divergences for any Spin Foam diagram

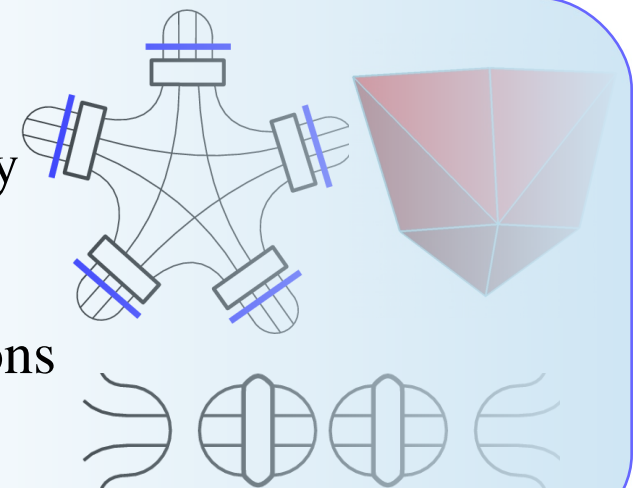

Thanks for your
attention!

A glance at EPRL & Booster Functions

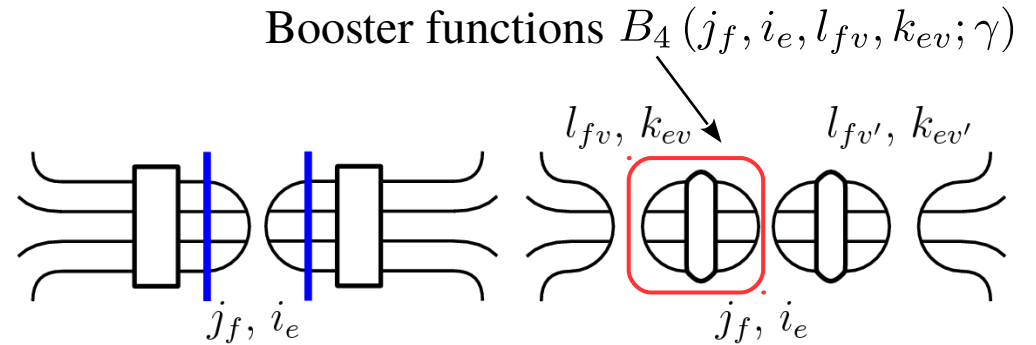
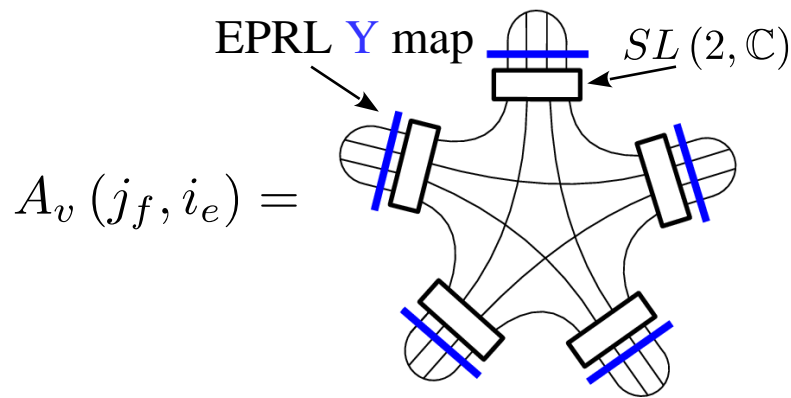

Decompose the EPRL vertex amplitude into a superposition of $SU(2)$ ones weighted by the Boosters (one per half-edge).

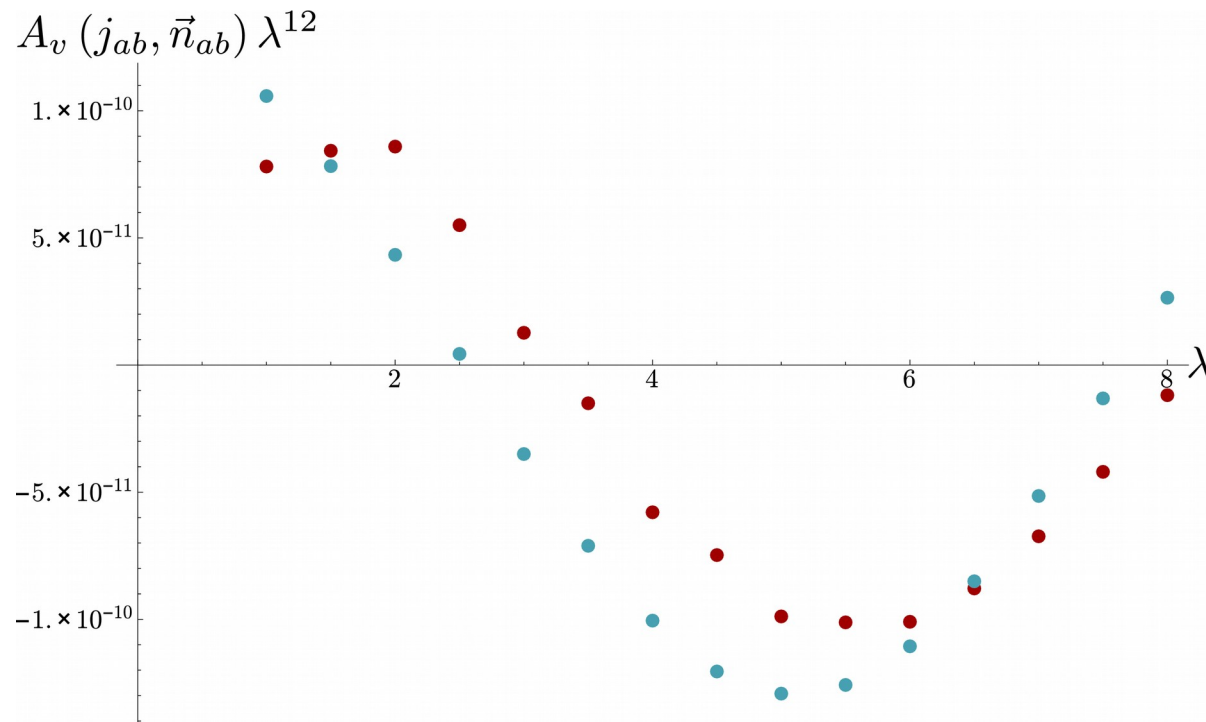

Vector Geometry

A collection of tetrahedra (polyhedra) with anti-parallel normals (up to a $SO(3)$ rotation per polyhedron) $\vec{n}_{ba} = -\vec{n}_{ab}$

We want to find a parametrization of the 15 dof ($3L - 3N$)

Visualization in the Kapovich-Millson dual space as a three dimensional polygon (2 d.o.f.)

Anti-parallel normals means you can glue two polygons together by superimposing normals

Iterating you obtain the following picture

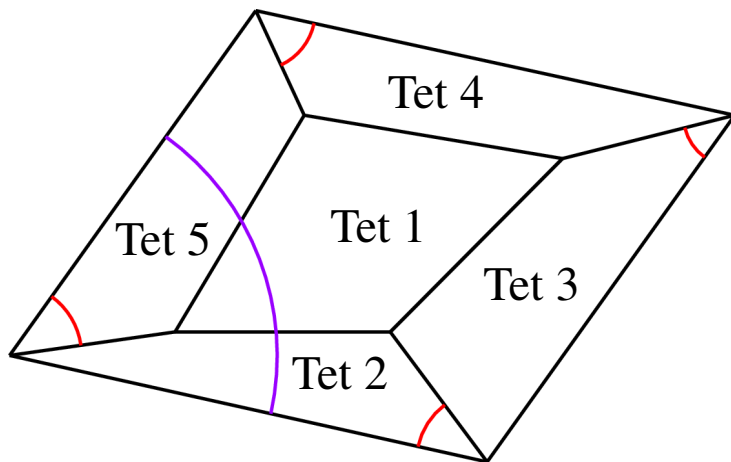
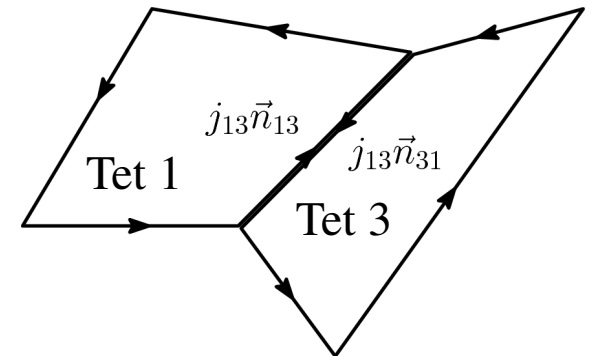
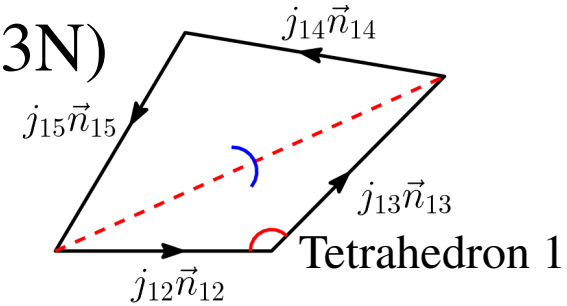

fully characterized by 15 numbers

10 areas j_{ab}

4 gauge invariant **angles** (3D dihedral)

1 non gauge invariant **angle**

Twisted Spike from a 4 simplex

(how to build boundary data from four dimensional geometry)

Denote with N_a the four dimensional normals to the tetrahedra

Pick a tetrahedron (e.g. tet 1) as reference, and rotate in \mathbb{R}^4 the remaining tetrahedra as to align their normals to N_1 .

These transformations leaves invariant the shared faces with the reference tetrahedron.

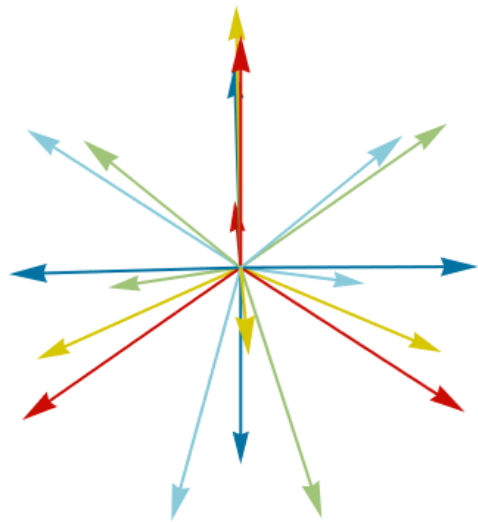
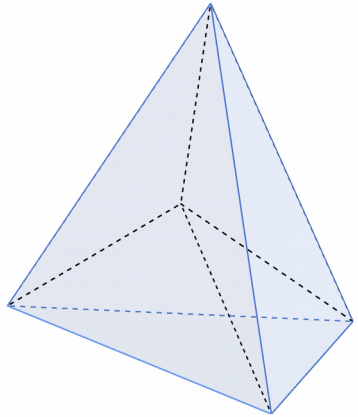

Rotate each tetrahedron in \mathbb{R}^3 around the normal of the face shared with the reference tetrahedron \vec{n}_{1a} of an angle equal to the 4D dihedral angle $\arccos N_1 \cdot N_a$ to obtain the twisted spike configuration

